



PS-20W-N-PL

20 Watts Projector Loudspeaker



EN 54 24



- superb sound
- high-impact ABS plastic
- BS 5839



EN 54-24:2008
Ref. Nr.: 021-32
ID-Code: SAA-LS32
0068-CPR-192/2023

AUDEMO-SYSTEMS GmbH Schatzbogen 62
81829 München, Germany

CE-Symbol gemäß Richtlinie 93/68EWG

APPLICATION

- Public Address and Voice Alarm
- Background Music
- Audio Visual

AREA OF USE

- Health
- Education
- Retail
- Hospitality
- Stadiums
- Transportation
- Theme parks
- Military

OVERVIEW

The 20W design speaker with an amazing concave shape is equipped with a 130mm full-range speaker and a 100V transformer with 3 power adjustments. Acoustically the design loudspeaker convinces at all levels. Thanks to a smart phase-shifting and a high-quality midrange resonator, the speaker offers a sound characteristic that is matching a 2-way system. In addition, the very wide dispersion ensures a comprehensive sound.

A robust, ABS plastic housing in RAL9016 and a stable aluminium mounting bracket guarantee a durable installation. The cable is fed via a cable gland (M12), for larger cable sizes the rear cable opening can be used. The integrated 2-pole ceramic block and thermal fuse as well as the moisture impregnation of the loudspeaker ensure additional safety.

The speaker is compliant with the British Standard BS 5839, Part 8.

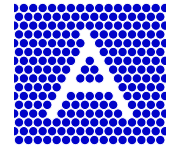

POLAR DIAGRAMS

Vertical isobars:

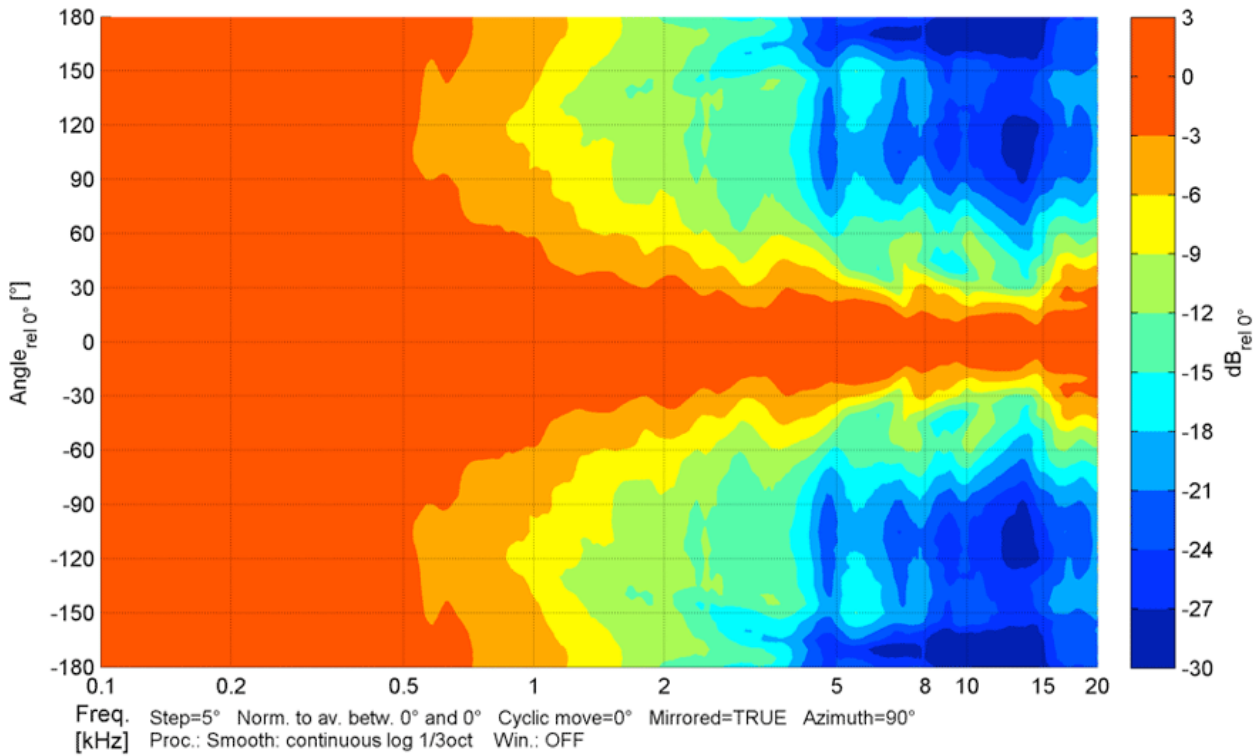

Horizontal isobars:

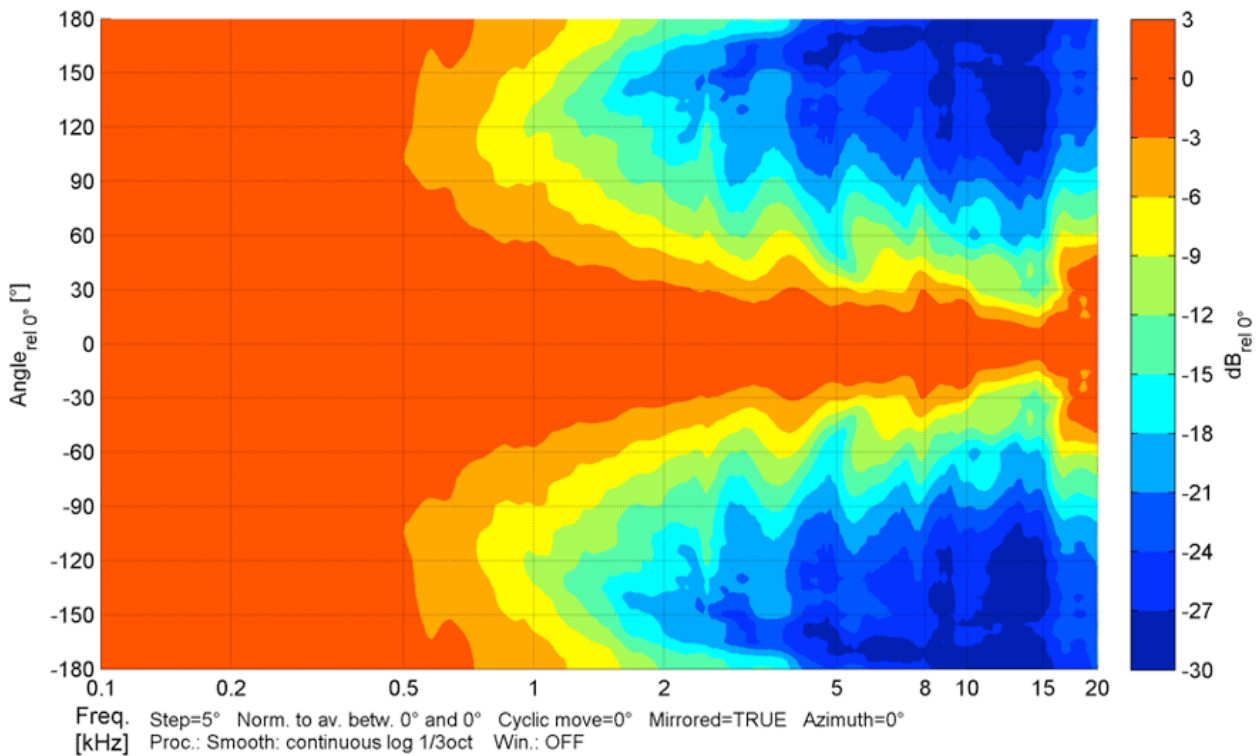

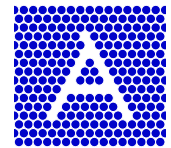

FREQUENCY RESPONSE DIAGRAMS

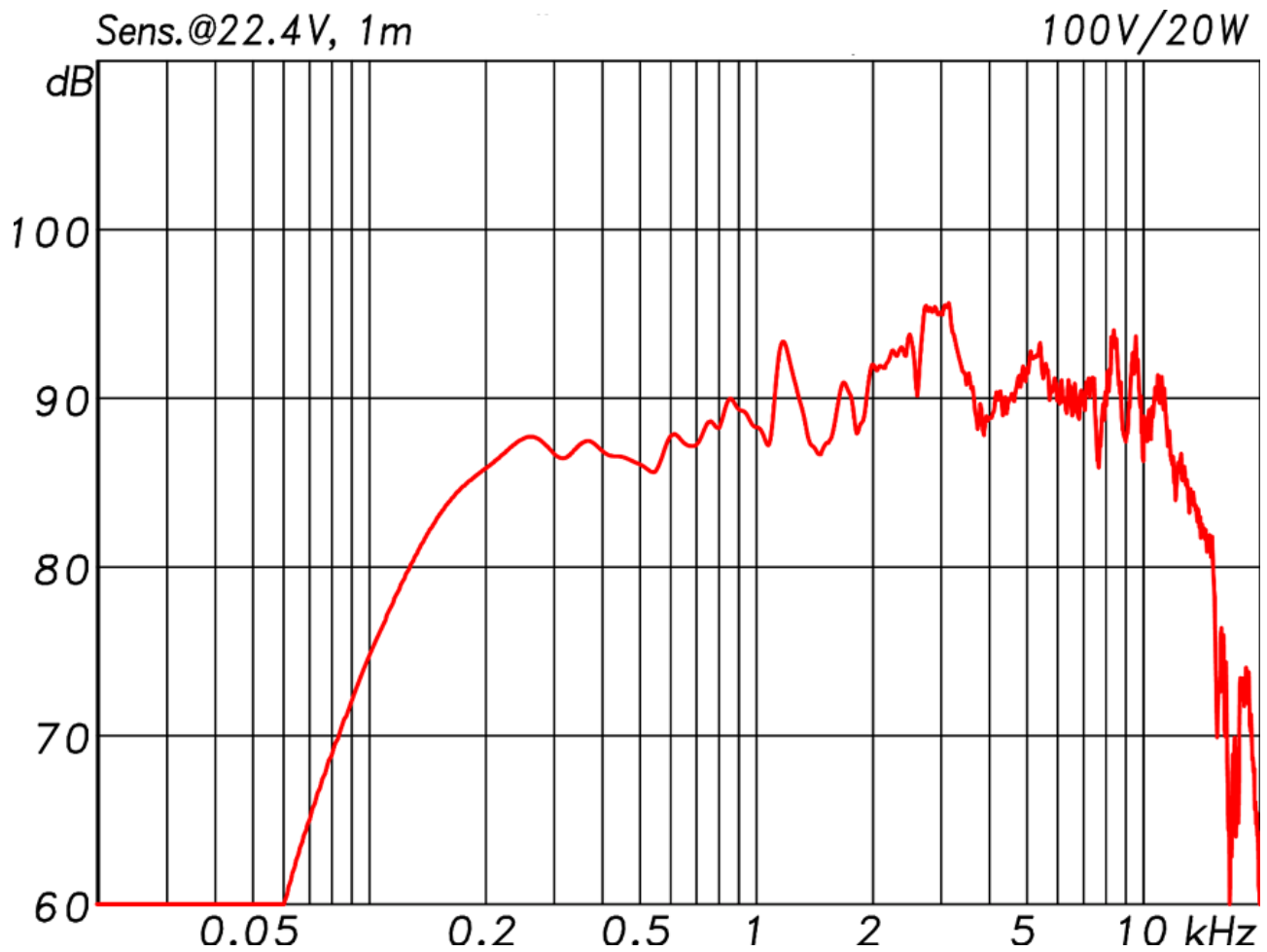



TECHNICAL DIAGRAMS

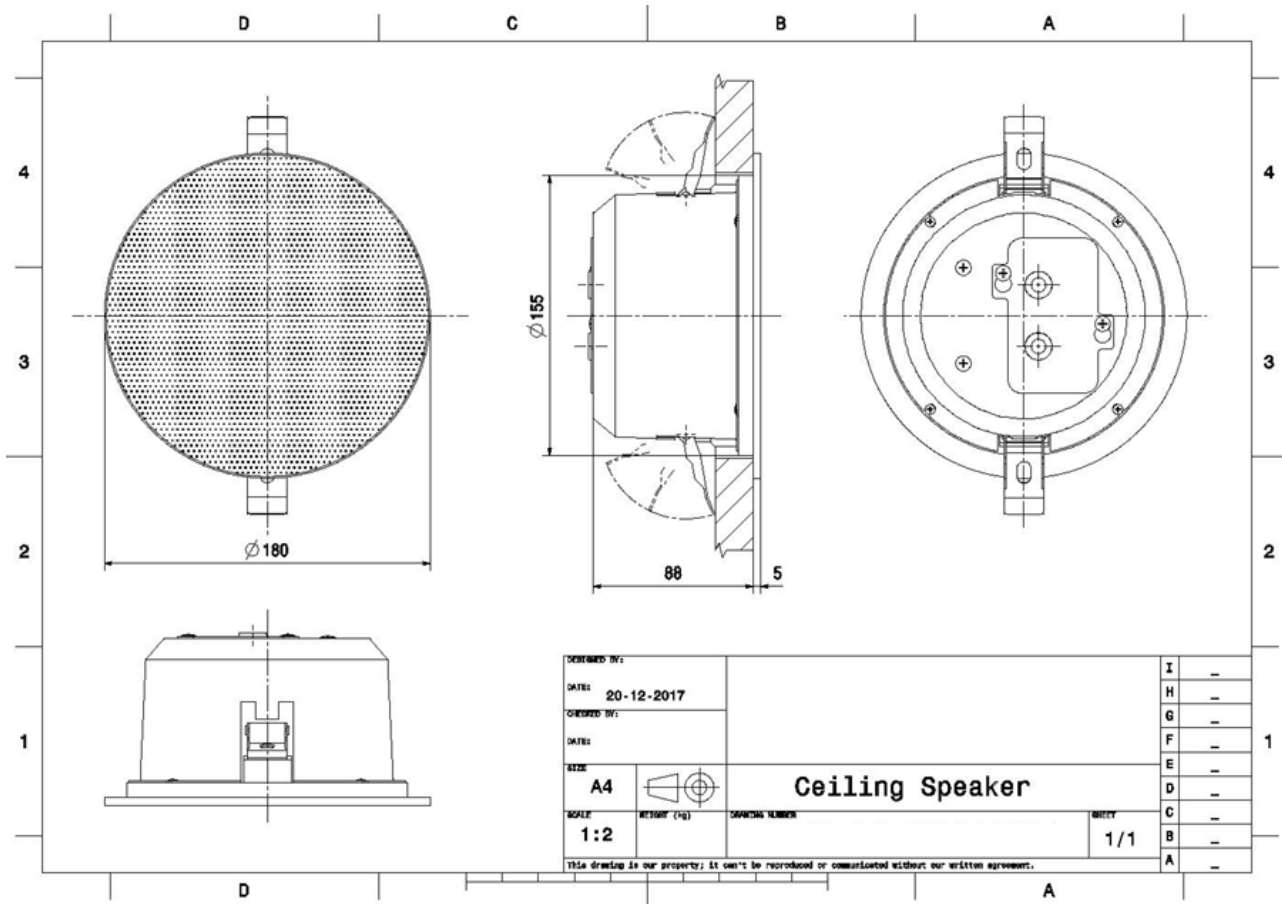

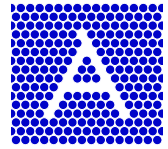

TECHNICAL DATA (ELECTRICAL)

Description	PS-20W-N-PL
Power	20/10/5 W
Impedance (100V)	500/1000/2000 ohm
Frequency Range	142 - 14.300 Hz
Frequency Response	112 - 15.800 Hz
Sensitivity, IEC268-5, 1W/1m	92,0 dB
Sensitivity EN54-24, Pmax/4m	88,0 dB
Sensitivity EN54-24, 1W/4m	76,4 dB
Sensitivity 1W/1m @ 1KHz	89 dB
Dispersion -6dB, 500Hz	h/v 360° / 360°
Dispersion -6dB, 1KHz	h/v 155° / 220°
Dispersion -6dB, 2KHz	h/v 95° / 85°
Dispersion -6dB, 4KHz	h/v 80° / 85°

TECHNICAL DATA (MECHANICAL)

Dimensions	169x 283,5mm
IP Rating	IP65
Weight (net)	1,76kg
Temperature range	-25 / +70 C°
Mounting	Mounting bracket
Connector	2-pin ceramic block
Maximum cable cross section	3,2 mm
Max. cable cross section loop	8mm ²
Colour	RAL 9016

All rights reserved.

Information contained in this document is believed to be accurate, however no representation or warranty is given and Audemo-systems in Germany assumes no liability with respect to the accuracy of such information.



Member of the ZVEI - Central Association
for the Electrical Engineering and Electrical
Industry eV Safety Association



AUDEMO - SYSTEMS GmbH (Headquarter)

Schatzbogen 62 81829 Munchen
Tel.: +49 (0) 89 1 4 56 78 47 - 0, Fax: +49 (0) 89 1 4 56 78 47- 2900
info@audemo-systems.de, www.audemo-systems.de