

CSST-AB-06W-100

6 Watts Surface Mount Ceiling Loudspeaker



EN 54 24



- Quick mounting Highest
- reliability
- BS 5839



EN 54-24:2008
Ref. Nr.: 004-15
ID-Code: SAA-LS14
0068-CPR-XXXX

AUDEMO-SYSTEMS GmbH Schatzbogen 62
81829 München, Germany

CE-Symbol gemäß Richtlinie 93/68EWG

APPLICATION

- Public Address and Voice Alarm
- Background Music
- Audio Visual

AREA OF USE

- Health
- Education
- Retail
- Hospitality
- Stadiums
- Transportation
- Theme parks
- Military

OVERVIEW

The CSST-AB-06W-100 is a surface-mounted ceiling speaker designed with two independent speakers and 100V transformers to enable an economic operation of two separated speaker lines (A/B-lines) for highest security demands. In case of a failure of one speaker line the redundancy of the chassis and the transformers will guarantee unimpaired function. The speaker is also compliant with the British Standard BS 5839, Part 8.

The 2 x 6W powered speaker is equipped with two full-range loudspeakers and two 100V transformer with 3 power adjustments, each. This sturdy ceiling speaker is made of powder-coated metal in white (RAL 9010). Flat and well designed speaker for unobtrusive installations, equipped with ceramic clamps and thermal fuses, protected against wet conditions by waterproofed chassis. Easy installation by the included rear plate made of metal, fixed by screws on the ceiling.

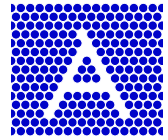

POLAR DIAGRAMS

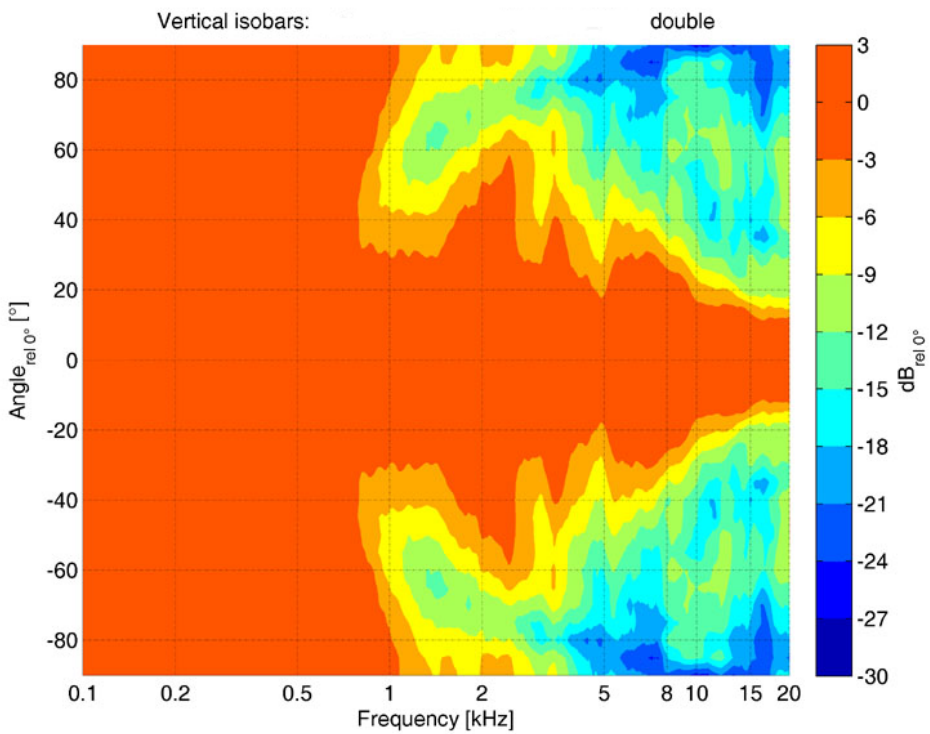
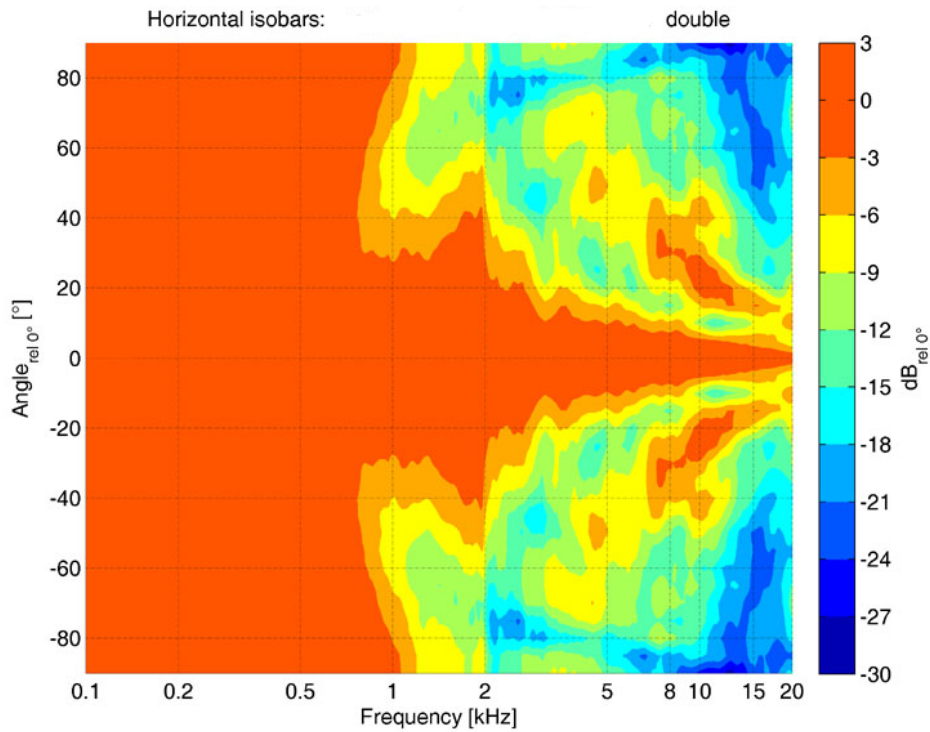

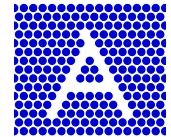

FREQUENCY RESPONSE DIAGRAMS

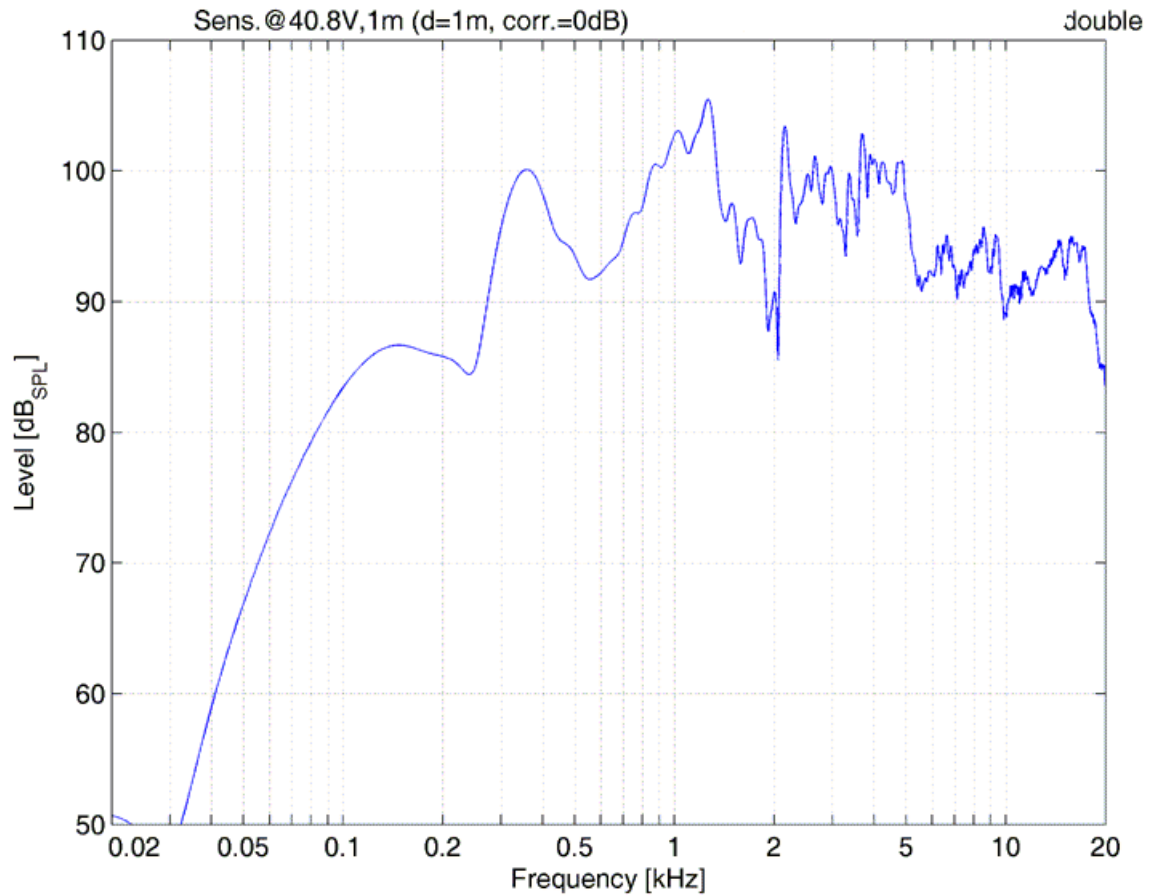

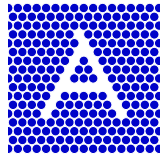

TECHNICAL DIAGRAMS

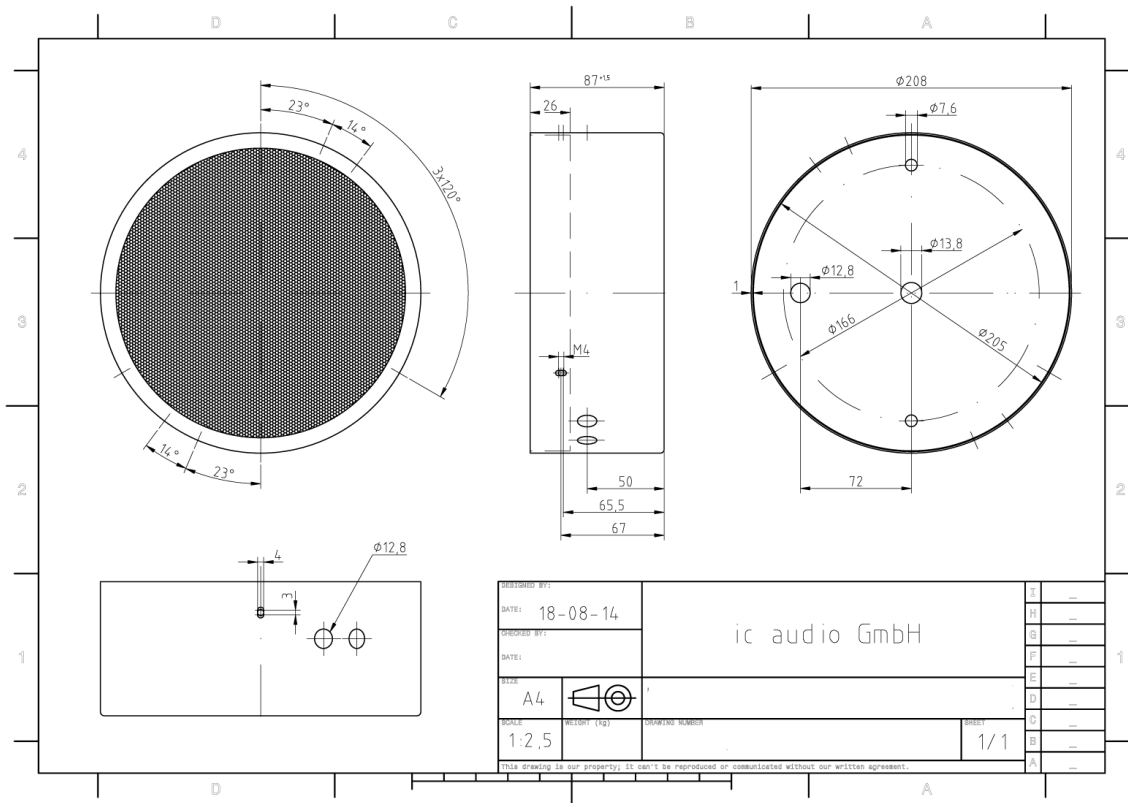

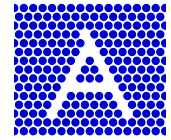

TECHNICAL DATA (ELECTRICAL)

Description	CSST-AB-06W-100
Power	2x6/3/1,5 W
Impedance (100V)	2 x 1667/3333/6667 ohm
Frequency Range	182 - 17.400 Hz (single) / 279 - 17.600 Hz (double)
Frequency Response	192 - 23.500 Hz (single) / 179-23.500 Hz (double)
Sensitivity, IEC268-5, 1W/1m	90,0 dB (single) / 92,0 dB (double)
Sensitivity EN54-24, Pmax/4m	86,0 dB (single) / 90,0 dB (double)
Sensitivity EN54-24, 1W/4m	78,0 dB (single) / 80,0 dB (double)
Sensitivity EN54-24, 1W/1m	90,0 dB (single) / 92,0 dB (double)
Sensitivity 1W/1m @ 1KHz	102 dB
Dispersion -6dB, 500Hz	single h/v 180° / double h/v 180°
Dispersion -6dB, 1KHz	single h/v 170° / double h/v 160°
Dispersion -6dB, 2KHz	single h/v 132° / 124° / double h/v 72° / 122°
Dispersion -6dB, 4KHz	single h/v 130° / 103° / double h/v 37° / 86°

TECHNICAL DATA (MECHANICAL)

Dimensions	208 x 89 mm
IP Rating	IP21
Weight (net)	1,90 kg
Temperature range	-10 / +55 °C
Mounting	Screws
Connector	2-pin ceramic block
Colour	RAL 9010

All rights reserved.

Information contained in this document is believed to be accurate, however no representation or warranty is given and Audemo-systems in Germany assumes no liability with respect to the accuracy of such information.



Member of the ZVEI - Central Association
for the Electrical Engineering and Electrical
Industry eV Safety Association



AUDEMO - SYSTEMS GmbH (Headquarter)

Schatzbogen 62 81829 Munchen
Tel.: +49 (0) 89 1 4 56 78 47 - 0, Fax: +49 (0) 89 1 4 56 78 47- 2900
info@audemo-systems.de, www.audemo-systems.de